

# Digital Programmable Heating Thermostat Manual

## Product Summary

This new design heating thermostat aims at market demand, it has large LCD display. Easy operation, complete functions .It can be control motorized ball valve, motorized valve, thermal valve, solenoid valve, heater, electric heating film, electric heating carbon crystal. It is used for floor heating.









## Technical Data

- ❖ Power Supply: AC200-240V, 50/60HZ
- ❖ Load Current: 16A(Electric Heating)
- ❖ Accuracy:  $\pm 0.5^{\circ}\text{C}$
- ❖ Set-point Temperature Range:  $5^{\circ}\text{C} - 35^{\circ}\text{C}$
- ❖ Limit Temperature Range:  $5-99^{\circ}\text{C}$
- ❖ Consumption:  $<0.3\text{W}$
- ❖ Temperature Sensor: NTC
- ❖ Size:  $86*86*17\text{mm}$  (H\*W\*D)









## Features

- ❖ Large LCD touch screen with blue backlight display and double temperature display mode
- ❖ Time display (minutes, hours, weeks)
- ❖ 6 period programmable controlling temperature setting
- ❖ Internal and external temperature sensor for choice
- ❖ Room temperature display precision is 0.5, inner precision is 0.1
- ❖ Setting temperature meet user's demand of room temperature
- ❖ Memory function when power failure, protect your setting from power failure
- ❖ Room temperature automatically calibration function

## Button description

NO.	signal	Description
1		on / off
2		Mode key: switch over auto/manual time interval control and temporary manual, long press to enter into time interval setting
3		Time setting: hours, minutes, weeks setting.
4		Increase temperature,press it together with  or  to plus programming data
5		Decrease temperature, press it together with  or  to reduce programming data

## Function and display

- “” manual control(temporary manual control when flashing, auto control when no this sign display);
- “” it is heating; “” open anti-freezing function;
- “” get up in morning, the first time interval; “” go out in morning, the second time interval;
- “” back home at noon, the third time interval; “” go out at noon, the fourth time interval;
- “” back home at night, the fifth time interval; “” sleep at night, the sixth time interval;

## Operation diagram

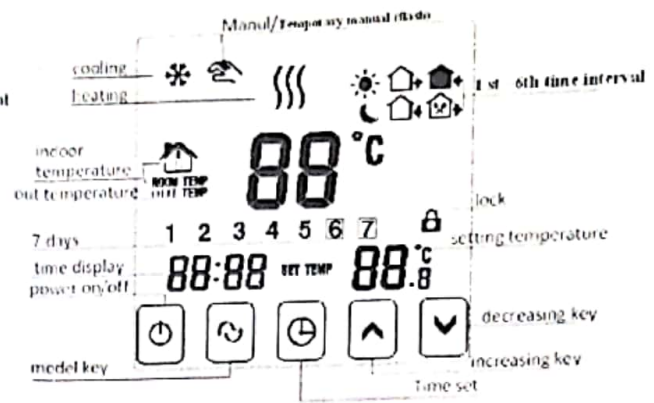
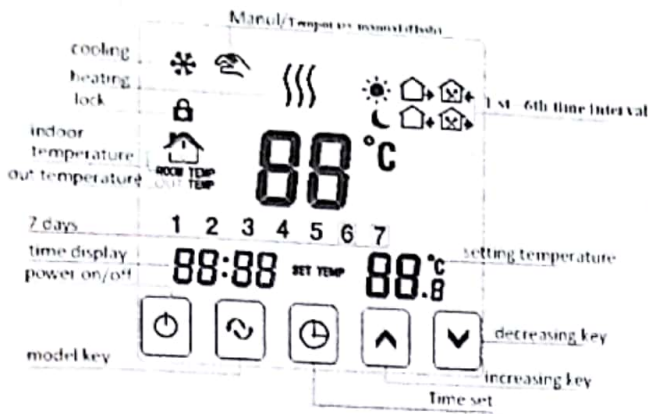

## Time and time interval setting

### 1) Time setting

Press time key "⌚", time zone display minute, hour, week, press key "▲" or "▼" to adjust time.

### 2) Time interval temperature auto control setting

First step, select time interval first, press "⌚/M" screen display "Loop" (cycle control), then press "▲", screen display "12345" (Monday to Friday control mode); press "▲" for 2 times, screen display "12345⏏" (Monday to Saturday control mode); press "▲" for 3 times, screen display "12345⏏⏏" (Monday to Sunday control mode);

Second step, time interval time and temperature setting, when screen display "12345" or "12345⏏" or "12345⏏⏏", press "⌚/M" enter into time interval temperature setting, press "⌚" enter into time interval time setting, press "▲" or "▼" to adjust and save automatically.

Note: when auto control "☁" will disappear, if need re-set temperature when auto control, can press "▲" or "▼" to adjust.

### 3) Modify interval time control setting

Press "⌚/M" first, then press "⌚" switch to the time option to modify time of time interval.

## Time interval programming

Press menu key "⌚/M", can enter into time interval setting, then press time key "⌚" can enter into interval time setting.

Period		Icon	Default Period Time	Default Period Temperature
Working Day	1	☀	06:00	20°C
	2	🏠➡	08:00	15°C
	3	🏠⊗➡	11:30	15°C
	4	🏠⊗➡	12:30	15°C
	5	🏠➡	17:30	22°C
	6	🌙	22:00	15°C
Weekend	1	☀	08:00	22°C
	2	🌙	23:00	15°C

1, The factory default temperature value of time interval 3 and 4 are the same as period 2, please modify default temperature when it's necessary.

2, Setting temperature is "00", this time interval is shutdown.

3, View out temperature value (floor temperature)

(1) Touch screen version: when internal control temperature and external limit temperature (high temperature protection), under power on state, press time key not move first, then press on/off key

together to switch and view external temperature (this time measure temperature display zone displays OUT TEMP temperature value),press time key to display room temperature;

(2)Button version: when internal control temperature and external limit temperature (high temperature protection),under power on state, press mode key not move first, then press on/off key together to switch and view external temperature (this time measure temperature display zone displays OUT TEMP temperature value),press mode key to display room temperature;

### Advanced Setting(suggestion: operated by technician)

(1)Touch screen version:under power off state, first press ⊖ not move, then press ⊕ together enter into advanced setting, it will save after backlight is out, press ↻ to set next data

(2)Button version:under power off state ,first press ▼ not move ,then press ⊕ together enter into advanced setting. ,it will save after backlight is out, press M to set next data

No	Symbols	Setting Item	Parameter Setting Function	Factory Default
1	SEN	Sensor control option	0:internal sensor 1:external sensor 2:internal control temperature, external limit temperature	0:internal sensor
2	OSV	Limit temperature value of external sensor	5-99°C	42°C
3	dIF	Return difference of limit temperature value of external sensor	1-9°C	2°C
4	SVH	Set upper limit temperature value	5-99°C	35°C
5	SVL	Set lower limit temperature value	5-99°C	5°C
6	Adj	Measure temperature	Measure temperature, check and calibration	0.1°C precision Calibration (actual temperature)
7	FrE	Anti-freezing function (only for water heating)	00:anti-freezing function close 01:anti-freezing function open	00:anti-freezing function shut down
8	POn	Power on memory	00:Power on no need memory 01:Power on need memory	00:Power on no need memory
9	ADD	Allow phone app to control thermostat (wifi version)	01:Allow 02-99: Not allow	01:Allow
10	FAC	Factory default	08:just display, no other meaning 00:Restore factory default(after adjust to 00,press press↻/M)	08

**Note:** hysteresis (return temperature) description: the factory default of external sensor limit temperature(OSV) set as 42°C, external sensor limit temperature hysteresis(dIF) set as 2,when temperature up to 44°C,relay stop output, when temperature drops to 40°C,relay output again and heating.(operation when room temperature lower than setting temperature)

### Sensor fault hint

Please select internal, external sensor working mode correctly. If it is choose wrong or sensor is fault (breakdown),LCD

interface will display "Err", temperature controller stops heating until fault is eliminated. Special Hint :installation cable

Please select: water heating selects 1.5-2.5mm<sup>2</sup> rigid line; electric heating select above 2.5mm<sup>2</sup> rigid line.

### Power wiring diagram

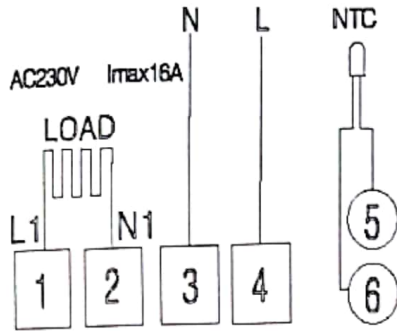

Electric heating wiring diagram

### Installation

**Warning:** please wiring right strictly according to the wiring diagram, do not make water, mud and other debris into the thermostat, otherwise it will cause thermostat damage!

<p>1,open main control panel, with 3.5mm slotted point screwdriver along the inclined plane until to card depths of 4mm, pry up slightly to open the card hook</p>	<p>2,connect back panel and power, wire as per wiring diagram, fasten back panel on cassette with M4 screw</p>	<p>3,connect winding displacement of back panel and upper panel</p>	<p>4, Hang up with 30° to 2 hooks, press on the 2 bottom corners, stuck on the upper shell, installation finished.</p>

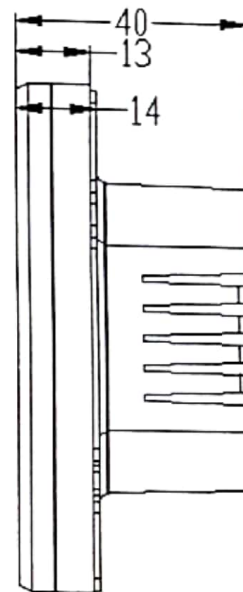
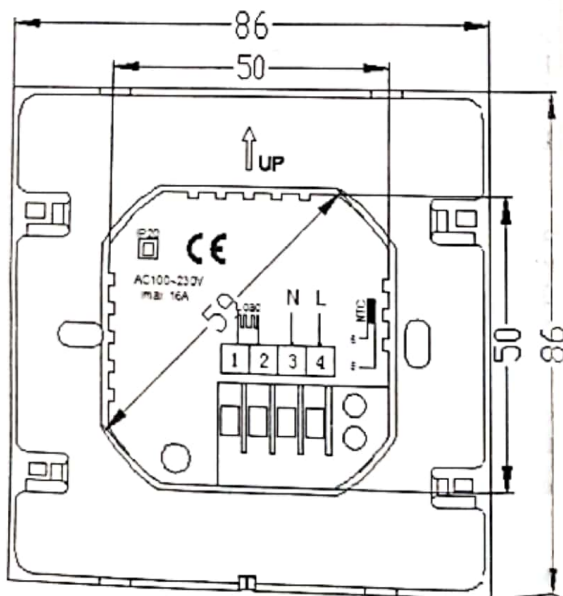

# Heating Thermostat WIFI Debugging Diagram

1.



EU Andorid APP

(Google play input "room heat eu" )



Andorid APP (Google play input "room heat" )



Iphone App (App store input "room heat")

## 2.Fill in local WiFi name and WiFi password



**Note:**Wifi name can't include the sign "-" and "\_",Wifi from router must be 2.4G, 4G wifi from the other mobile phone hotspots is also ok, 5G router wifi is not ok.

## 3.In power off state:

Touch screen version: press and hold on the "⏻" button, then press the "⏻" together

Button version:press and hold on the "⏻" button, then press the "⏻" together.

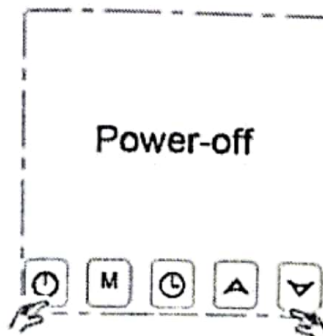
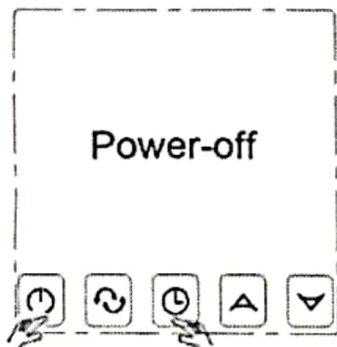

4. Enter to the advanced setting, then press the "M / ⌂" for 9 times until appears the "FAC"

"FAC"

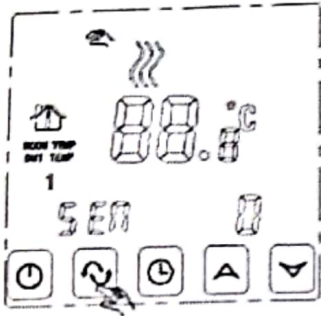

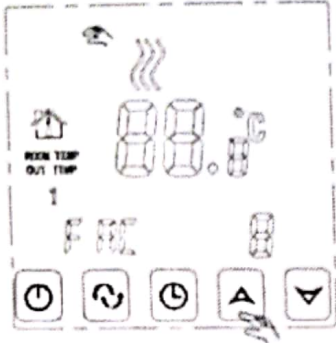

5. When appear the "FAC" button, then press the "A" button and up-regulation to "10" or "32"

"32"

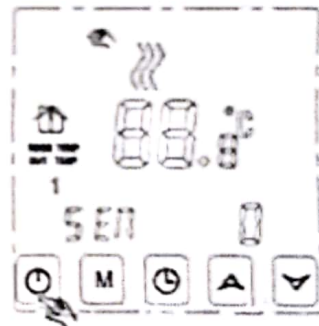
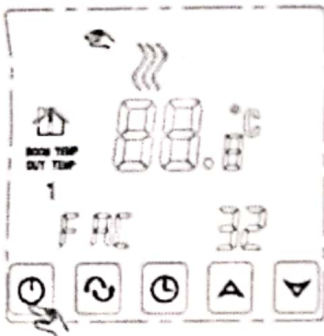

6. Press  to turn off



7. Press and hold on the "" button, then press the "", the wifi icon begin to flashing  
WiFi fast flashing

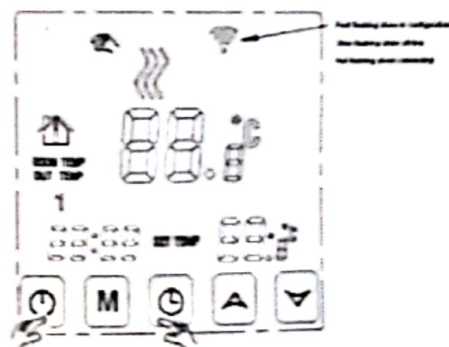
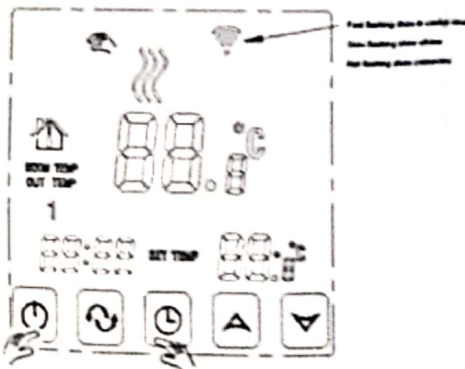



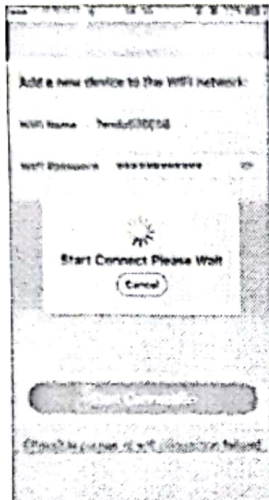

8. Press start connection on the phone, if thermostat and the mobile phone connection is success, the WiFi icon will stop flashing

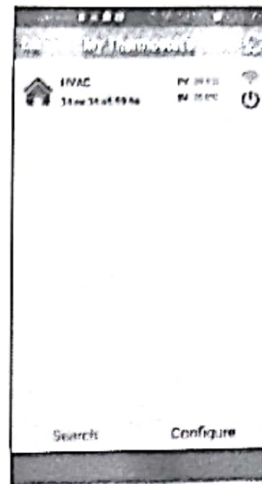





9. Finished configure, get to the search list and click the thermostat equipment





10. Press current equipment  HVAC  34.00 34.00 34.00  , then it will display setting screen

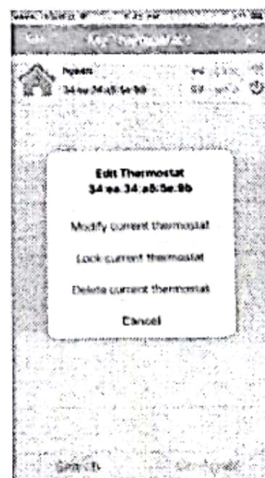

## Icon Description of WiFi interface

Long press right position of  HVAC  34.00 34.00 34.00  , then can edit thermostat, As right screenshot



Press , correction time

Press , lock or unlock thermostat

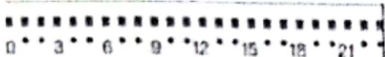
Long press  to set weekly programmable.

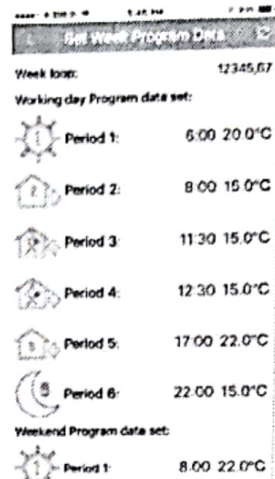

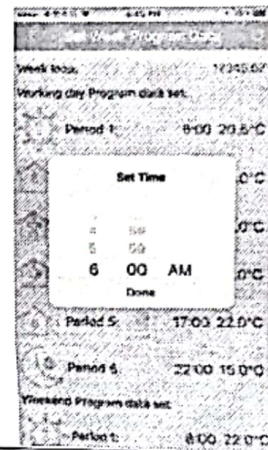

If want modify Period 1 temperature and time .please press **6:00 20.0°C** .As right screenshot. It is same method to modify other period

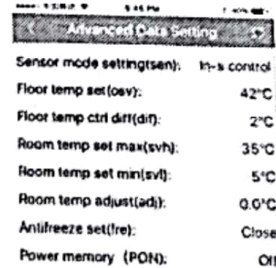

Press  to set advanced option.As right screenshot



Press  to turn on or turn off

Press  to switch auto or manual mode

V201810